

Magnescale

SPEED X PRECISION



Corporate Profile

Into the Infinite World Beyond Micro

BEYOND MICRO

INTO THE INFINITE WORLD

* “渺 (byo)” is a metric unit denoting a factor of 10^{-11} .

Perfecting ultra-high precision

There is constant competition to develop new technologies for products such as machine tools and electronic devices.

Entrusted by our industry leading partner companies, we are relentless in our pursuit of cutting-edge technologies.

Forming new values

In the infinitely expanding world of extremely high resolution Magescale is constantly striving to develop ultra-high precision measurement technologies. We will continue to provide support for the creation of cutting-edge technologies that can open up paths to the future.

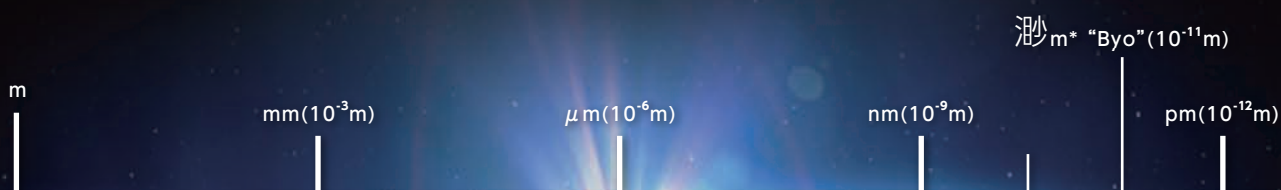

- 4.5 ▼ Message
- 6.7 ▼ Products - Magescale
- 8.9 ▼ Products - Laserscale
- 10.11 ▼ Products - Digital Gauge
- 12.13 ▼ Research & Development / Production & Quality Control
- 14.15 ▼ CSR activities
- 16.17 ▼ History
- 18.19 ▼ Business Bases (Plants and Offices)

Magnescape

SPEED X PRECISION

— With a motto to continually enhance capabilities and technologies while maintaining a spirit of creativity and ingenuity —

Ever since the establishment of the company in 1969 and the development of unique Magnescape products, we have been striving, through the support of our many customers, to provide high-speed and high-precision measuring devices that are easier to use. During that time, the industries of the world have continued to evolve and advance while technological innovation in information equipment has been particularly pronounced. This has driven ever greater convenience in society as technology becomes more sophisticated. However, as a result, we are now faced with serious issues related to the earth's resources and environment. This has ushered in an era wherein resolving these issues, while maintaining this newfound convenience, has become a serious global problem. To achieve this goal, it is imperative that the world's production sites more efficiently produce high-quality products, with better yields, that can be used for longer periods. In this regard, we believe that the measuring devices and scales that we produce have a key role to play. Accordingly, our aim is to provide products and services that meet the needs of the times based on our motto to continually enhance capabilities and technologies while maintaining a spirit of creativity and ingenuity.

Toru Fujimori, President

藤森 徹



Message

Magnetism

Magnetism is the action or characteristic of a magnet that enables it to attract a piece of iron or point to the north and south.

Data source: Daijirin (Japanese dictionary), published by Sanseido Books

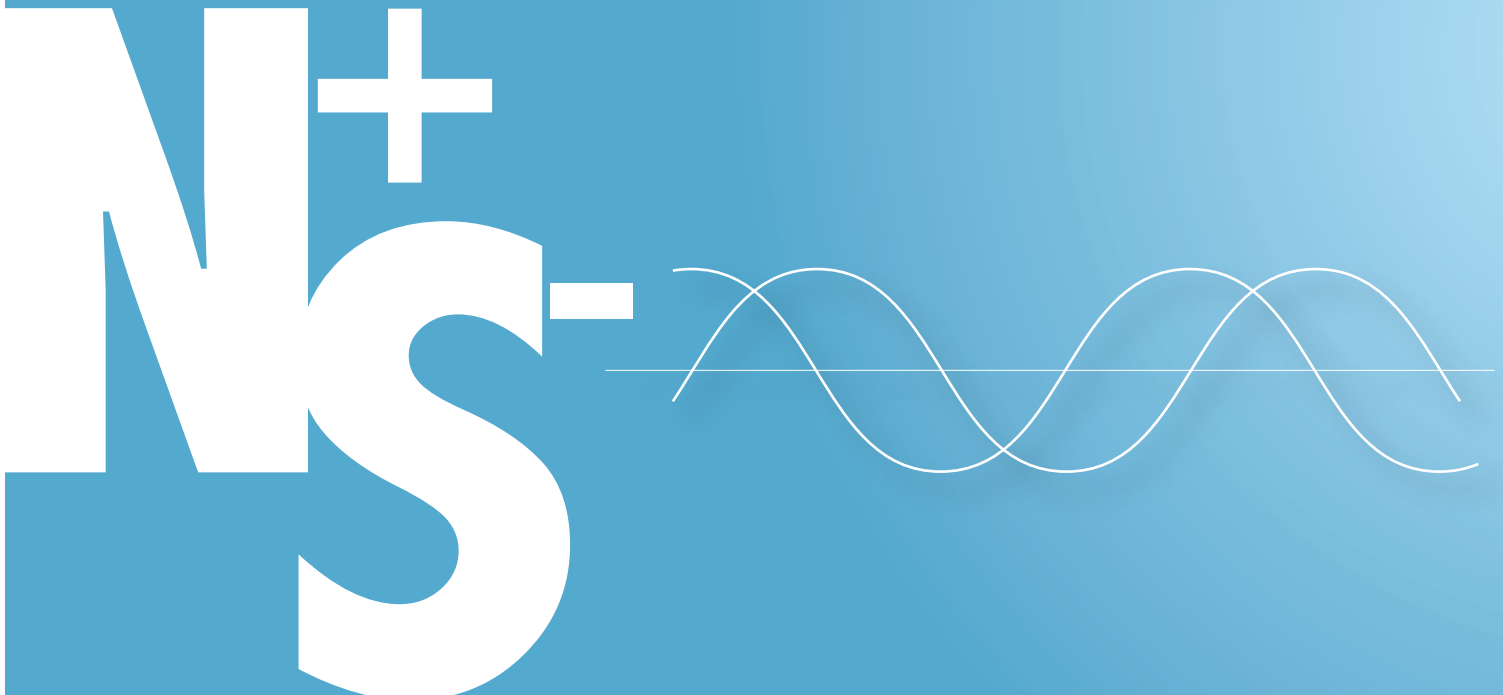

Products – Magnescale

Environmental resistance and high precision

Absolute Magnescale has earned a high reputation for its superior position and angle control performance and environmental resistance under severe operating conditions. Magnescales are widely used in the CNC (computer numeric control) machine tool industry.

We offer various absolute linear Magnescales, including the SR67A robust type and SR27A slim type. Both models have excellent environmental resistance and can achieve a high response speed of 200 meters per minute with a resolution of 10nm.

We also provide a lineup of absolute rotary Magnescales, from the RU77, with an inner diameter of 20 mm, to the RS97, with a large inner diameter of 180 mm. The RU77 is assembled with bearings and is easy to install. These models offer a high resolution, with a maximum 25 bits per revolution, and a scale accuracy of +/-2.5 seconds.

Magnescales have the same thermal expansion coefficient as the iron used in the structure of machine tools. Therefore, these scales can deliver high positioning precision and stability.



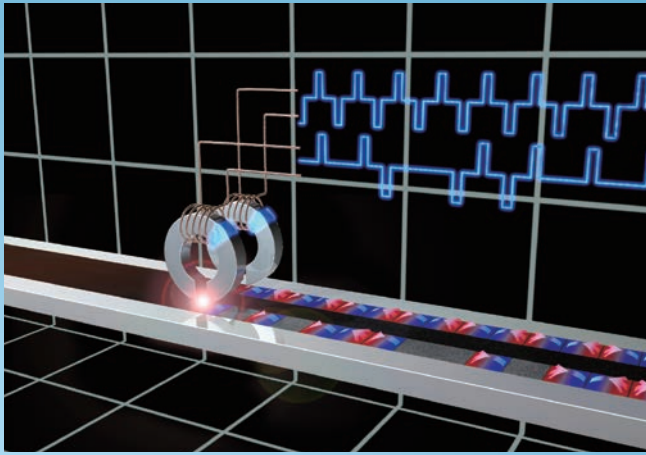

Technical topics

- Absolute Magnescale products comply with communication protocols of all major CNC manufacturers throughout the world.
- Magnescale has acquired third-party functional safety certification.

Three high-quality features for outstanding precision measurement

Highest level of precision with a Magnescale installed on your equipment
Magnescales are made of an extremely rigid iron material that prevents equipment vibration from affecting its precision. Furthermore, the company's proprietary sensor detects low-distortion signals and removes extremely small errors from the detected signals, using an exclusive algorithm, to provide exceptionally precise scales.

Superior vibration resistance and thermal performance

The Magnescale housing base consists of an extremely rigid iron. Therefore, the scale has the same expansion coefficient as the structure of equipment such as machine tools, which allows it to perform stable position detection. The extremely rigid design of the scale offers high vibration resistance.

Superior environmental resistance

Vapor and oil, which can affect the use of scales, are non-magnetic bodies with a magnetic permeability equal to that of air ("1"). In environments where equipment such as machine tools are used, vapor and oil do not affect the magnetic field generated by the scale materials. Therefore, Magnescales provide highly accurate signal detection. Since the transmittance and refractive index of vapor and oil are optically different from air, accurate signal detection is difficult using a detection principle that uses light.

Can be interfaced with SIEMENS DRIVE-CLiQ 840D

Magnescale has added various models to its product lineup that comply with "Functional safety standards (IEC61508-2010, ISO13849-1:2008)", which are machinery directives that apply to the European region.

This model has been designed with redundant internal circuits and a mutual monitoring function to prevent dangerous events such as loss of life from occurring, even in emergencies.



Magnescale
SR67A

Pico (symbol: p)

Pico is a prefix in the metric system denoting a factor of 0.000000000001 (10^{-12}).

Data source: BINARY IT Term Dictionary



10⁻¹² m

Products – Laserscale

Into the world of pico

Laserscale products perform measurements of resolutions beyond the nano scale and have entered the even higher resolution world of the pico scale. The resolution factor has been evolving quickly in order to meet customer demand, and Moore's Law* holds true for this pace of improvement. Laserscale provides ultra-high resolution and stable measurements for the most advanced measurement and positioning control.

Laserscale is indispensable for sectors that require high-precision and high-resolution, such as next-generation semiconductor manufacturing and the die-cutting processes for optical components such as digital camera lenses.

A high-performance rotary encoder Z sensor has been added to the two-dimensional scale to further expand the possible applications for Laserscale.

* Moore's Law

Moore's Law, a rule related to the progress of semiconductor technologies, states that the integration density of semiconductor chips doubles approximately every two years.

This law is named after Intel co-founder Gordon E. Moore, who coined this rule of thumb in 1965, based on his experience.

Data source: BINARY IT Term Dictionary

Laserscale BF1



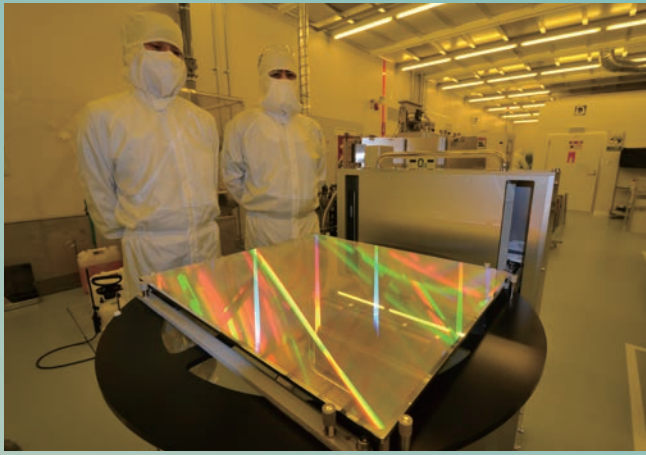

Technical topics

Two-dimensional scale

- Developed a large two-dimensional scale with dimensions of 600mm x 700mm
- High-precision measurement that suppresses errors to less than 1 nm by compensating between sections.

Optical fiber type Laserscale

- Laserscale's measurement head operates with a power consumption of 2 mW or less. Its light source is provided outside of the measurement head and the lights are guided using optical fibers.
- No thermal drift and highly stable measurement performance and repeatability.

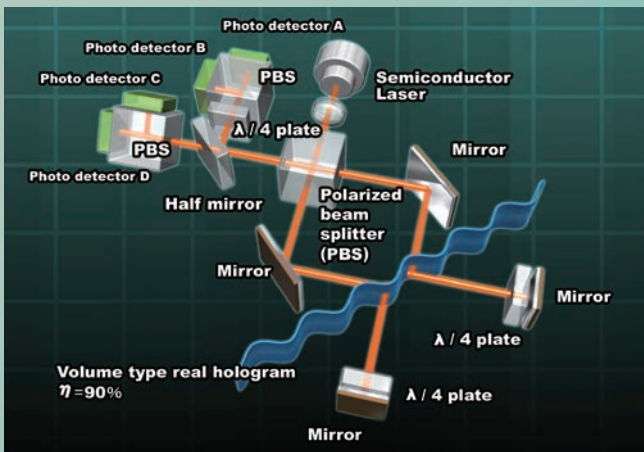

Grating interferometer technique and hologram scale

Laserscale is a unique scale which utilizes the technology of a hologram for the scale and a semiconductor laser for a light source. It applies the use of the grating interferometer technique. When a standard interferometer that performs measurements based on the wavelength of lights is used, a significant error will occur due to changes in the light source wavelength and refractive index caused by temperature and humidity. Laserscale, on the other hand, performs measurements based on a hologram and thus demonstrates unparalleled stopping accuracy and repeatability. Since the light paths of the two beams that interfere with each other are always the same length, no errors occur even when there are changes in the wavelength of the light source.

The beams, which are diffracted twice in the opposite direction by the scale, interfere with each other at four photo detectors. These diffracted beams have a signal wavelength that is one-fourth of the scale's grating wavelength. Laserscale makes it possible to obtain high-quality signals with fewer DC fluctuations and produce a signal wavelength of $0.138\mu\text{m}$ (which is more than double-digits finer than a standard optical scale).

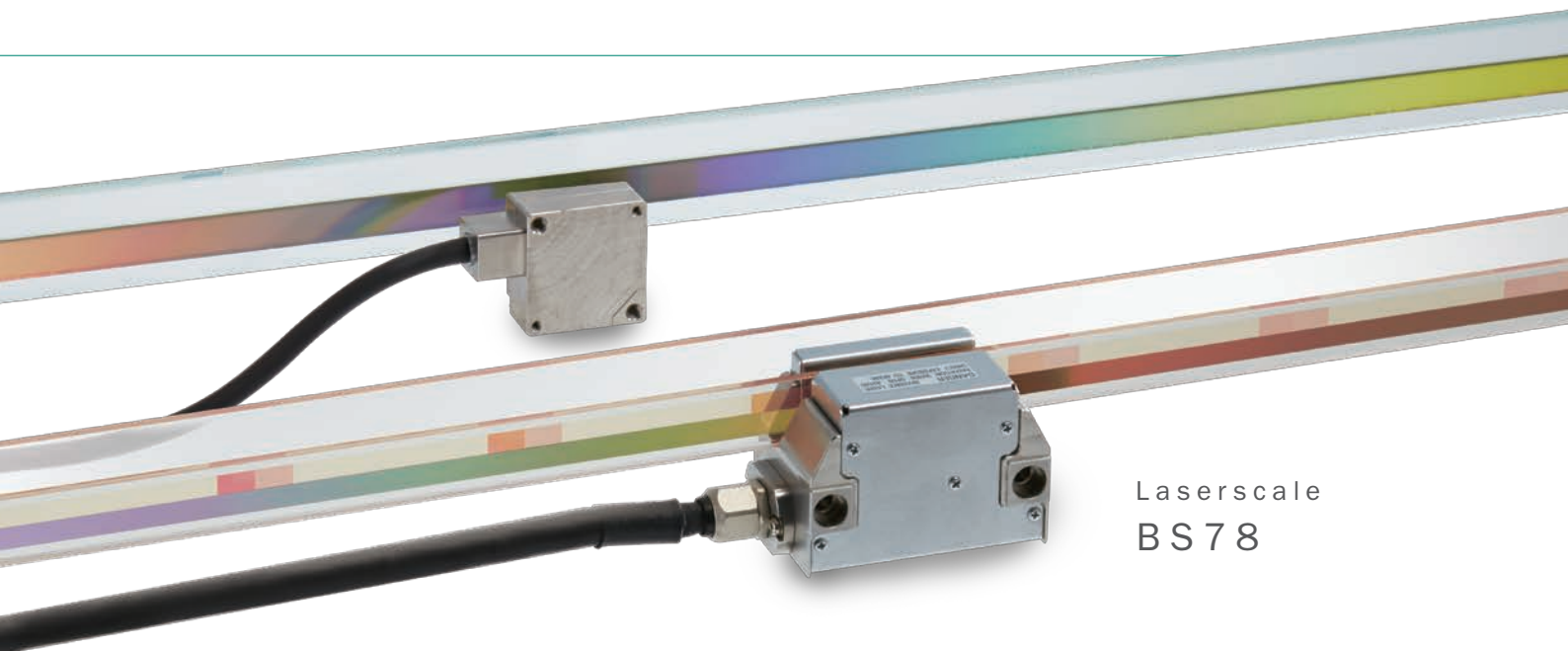

Laserscale
BS78

Sliding performance

The ability to make high-precision measurements possible in all kinds of environments by providing a low-friction and highly-rigid body with high-tracking performance using movement without play..

Data source: Magnescale Co., Ltd.



Products – Digital Gauge

High quality and reliability inherited from predecessor models

Magnescale's extensive know-how is concentrated in its high-quality magnetic recording media and detection technologies. Our high-precision digital gauges offer high-resolution in a compact body. These products are well received and have been used over a long period of time by automobile and appliance manufacturers who demand very high quality control standards.

We have added the DK800S series third-generation digital gauge to our lineup as a representative of the next-generation digital gauge. The DK800S series offers even more stable measurement performance and long life, along with high resistance to environmental conditions, impact, and vibration that can be achieved only through the use of magnetic technology.

Furthermore, we have developed a new interpolation technology to reduce the size of the circuits. We are developing a wide range of digital gauge products that can be adapted to various industries and applications. For instance, the compact DF800 series and MF10 series with excellent operability which uses the same gauge technology as the DK800S series.

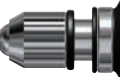

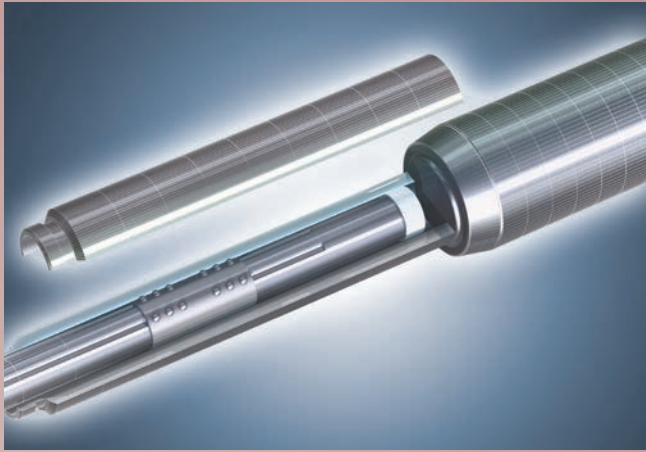

Technical topics

- High-rigidity design tested 60 million cycles.
- High tracking performance that enables measurement of a variety of shapes.

Sources of “sliding performance”

High precision and stable measurement

High-quality signals are received from the sensor and scale gratings, which operate on the same principle as Magnescales. These signals are output after being converted into the specified resolution and pulse by the signal processing circuits located downstream.

In the signal processing circuits, signal deviations that cause errors such as DC displacement and unbalanced gain of signals are removed by means of an advanced algorithm. As a result, stable precision can be maintained over a long period of time. Furthermore, signal processing is performed in real time, which allows continuous measurement data to be obtained.

Extreme rigidity and long-term reliability

Our digital gauges adopt Magnescale’s newly developed original ball spline in order to improve the sliding performance of the spindle which is a critical component in the gauge assembly. The spline groove is designed for making linear contact with the ball bearings. This spline groove has five times more resistance to radial loads compared with conventional products (comparison by Magnescale).

At the same time, position displacement and rattle, which are caused by spindle rotational force, have been reduced to nearly zero.

High environmental resistance

Vapor and oil, which can be factors that affect the use of scales, are non-magnetic bodies with a magnetic permeability equal to that of air (“1”). In an actual operating environment, such as an automotive plant, vapor and oil do not affect the magnetic signal in the scale. As a result, the scales can perform accurate signal detection.

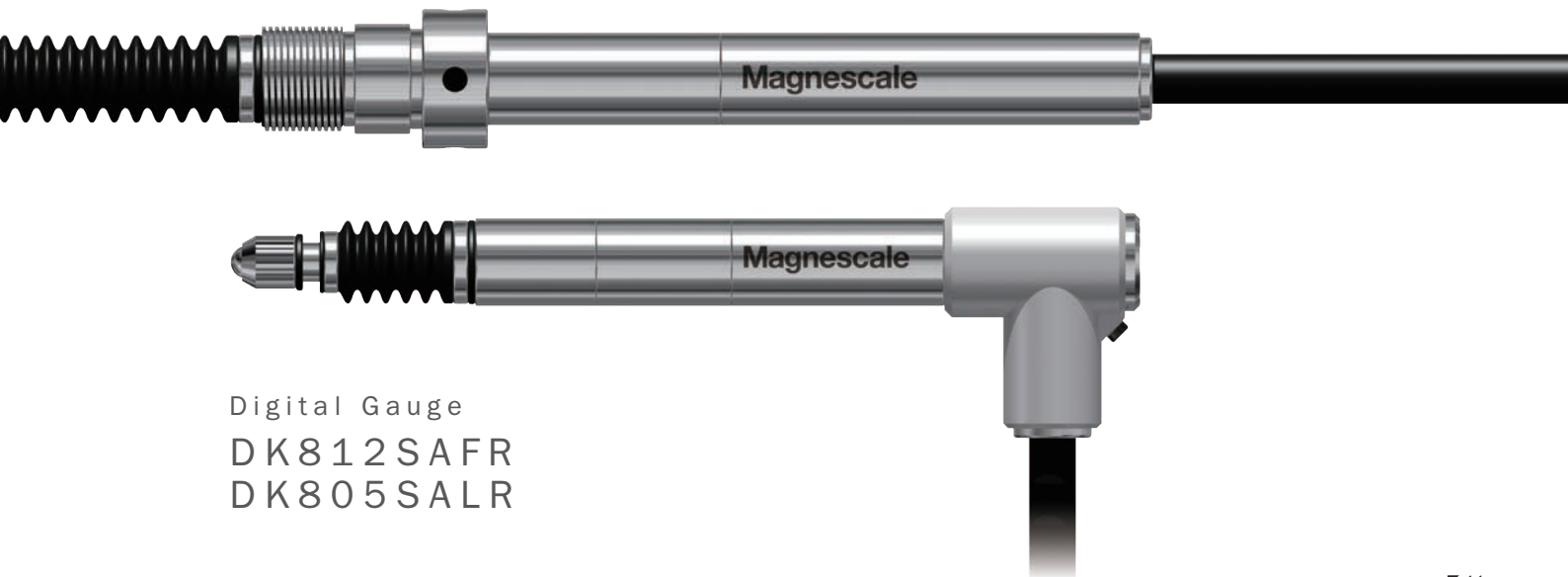
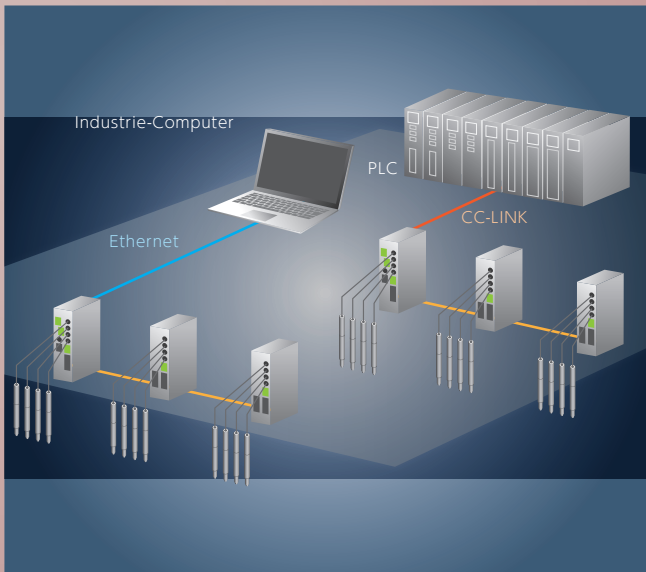

Digital Gauge
DK812SAFR
DK805SALR

Research & Development

Research and development of cutting-edge fundamental technologies for Laserscales and Magnescales

Magnescale continues its diligent efforts in the research and development of new sensors, devices, and measuring systems and improvement of precision measurement technologies, to meet the needs of next-generation customers.

We are conducting research and development with top semiconductor fabrication equipment manufacturers and machine tool manufacturers around the world. Our goal is a shared roadmap for the development of next-generation measurement technologies.

We strive to develop essential technologies within the company and also through joint research with universities and research institutes. We also provide opportunities for young engineers to learn about these technologies and acquire qualifications so that they can advance their careers through research and development activities. For example, we have personnel exchange programs and enrollment in doctorate degree programs for adults.



Production & Quality control

Quality management system

Magnescale produces high-safety, high-quality, and highly-reliable products. For that purpose, we have established a total quality control framework from the designing phase to the manufacturing phase to assure 100% customer satisfaction. We also operate a quality management system that complies with the international standard ISO 9001 to achieve continuous quality improvement. Magnescale has acquired the ISO 14001 environmental management certification and manufactures eco-friendly products.

Product evaluation facilities

Magnescale has installed various environmental testing equipment such as thermostatic chambers, hot and cold shock testing equipment, and vibration and shock testing equipment. This equipment is used to perform verification of product safety and reliability. We also have an electromagnetic compatibility (EMC) testing facility with extremely high standards. Therefore, we can quickly evaluate noise problems, of which worldwide regulations are continually becoming stricter. Furthermore, we have installed chemical analysis equipment and out-gas analysis equipment for vacuum compatible scales. This equipment enables us to work to protect the global environment as well as carry out product evaluation in accordance with each customer's working environment.

Traceability

A precision measurement system that is traceable to national standards and ultra-precisely controlled temperature environments are extremely important in assuring scale performance. We have a qualification for the "length" calibration accreditation service and offer products that are traceable to national standards of the National Institute of Advanced Industrial Science and Technology (AIST).

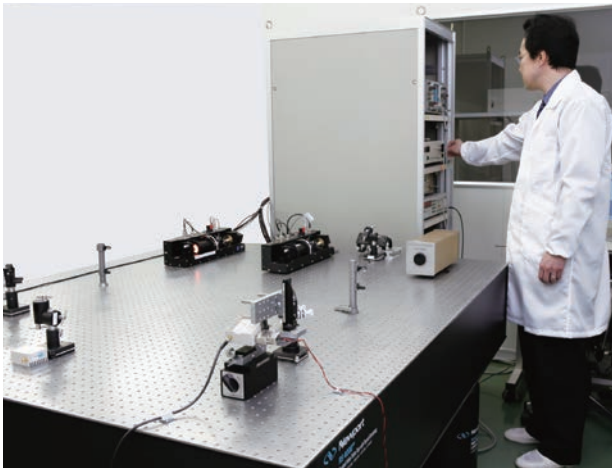

Iodine-stabilized laser traceability system



Anechoic chamber



X-ray fluorescence (XRF) analyzer



Gas chromatography- mass spectrometry (GC-MS) instrument

CSR Efforts

Magnescale's Corporate Social Responsibility (CSR) program implements management policies through business activities, and aims to make contributions to sustained development through sincere handling and response to the stakeholders' trust.

Management Mission Statement

We aim to become the world leading company in the measuring instrument field through our supply of innovative, high-precision, durable, and trouble-free measuring instruments with optimal services and cost.

We strive to continually improve productivity and efficiency for our worldwide customers through the latest and most advanced product development technologies, precise and meticulous production technologies, and accurate and prompt sales and services.

As befits a worldwide corporation, we will:

Emphasize company-wide communication with the recognition of earnest and enthusiastic team-oriented efforts;

Respect each other's opinions and continually develop through friendly competition in energetic and cheerful workplaces. Foster a fair and open corporate culture, utilizing appropriate management initiatives.

As profitability is a goal of all healthy business organizations and in keeping with the true nature of the measuring equipment industry, we will:

Work to enhance corporate values and increase profits for our shareholders who are knowledgeable of the measuring equipment industry.

Always remember that the pricing of our products and services is an integral factor of the prosperity and perpetuity of the corporation;

Generate suitable profits to ensure the cash flow necessary to provide for the healthy operation of our corporation, research and development, stable customer services, employee training and development, and, the maintenance of safe and efficient manufacturing facilities.

As an industry leader and responsible corporate citizen, we will:

Contribute our fair share to our local community and society;

Conserve environmental resources at all times to preserve the global environment;

Incorporate the highest standard of ethics while still encouraging an aggressive approach to our business activities.



Examples of CSR activities

Business continuity planning (BCP)

Magnescale's products bear social and supply responsibilities in their role as crucial devices for maintaining the manufacturing equipment in various industry sectors, even in the event of a disaster. For that reason, we have defined a business continuity plan (or BCP) with a focus on large-scale earthquakes as the major risk factor. We assure the life and safety of employees and visitors, distribute to our manufacturing sites, and keep basic parts in stock. We have also selected suppliers for the procurement of substitute components. Through these efforts, we try to minimize any adverse effects on our customers' production activities in the event of an emergency or disaster.

Environmental considerations

Magnescale has defined the company's own chemical substance management standard for specific chemical substances contained in products and components. This in-house standard reflects relevant global laws and regulations and customer views. We have set up a framework that complies with Registration, Evaluation, Authorization and Restriction of Chemicals (REACH) regulations and the Restriction of Hazardous Substances (RoHS) Directive of the European Union. We have acquired the environment management certification (ISO 14001) and try to protect the environment in every way. At the same time, we are making significant progress in saving energy through shorter equipment operating times by improving productivity, higher efficiency by facility maintenance, and power-saving efforts by each employee.

Safe work environment

Based on the occupational health and safety risk assessment, Magnescale takes various actions to reduce risks (such as weekly workplace inspection by top management) and full compliance with laws and regulations and requirements. We also maintain a safe and comfortable work environment through health promotion activities.

Social contribution

Magnescale dispatches free service teams during earthquakes and other disasters to provide support for an early recovery of the production activities of local customers.

Notification to employees

Magnescale is making an effort to increase CSR penetration for each employee by summarizing the company's management policies, code of conduct, compliance guidelines, and other important regulations in an employee handbook and distributing this handbook to all employees.

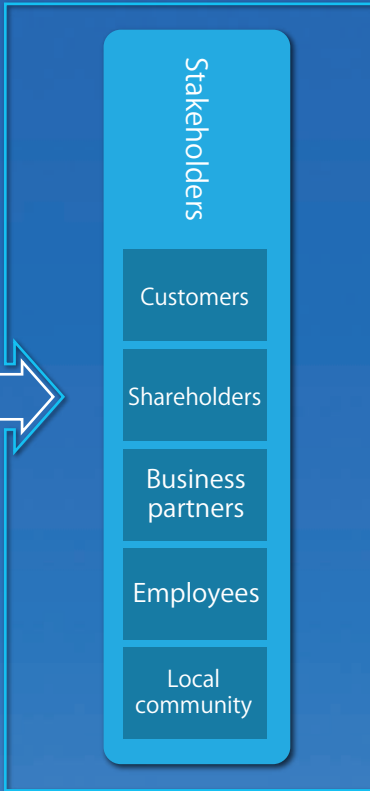

Quality management system
ISO 9001:2008 certified



Environment management system
ISO 14001:2004 certified



Radiation monitoring and
control process certified

1968



Flux response-type rotary scale
MSS200

Announcement of magnetic
measurement technology

1968



Flux response-type linear scale
MSS-101

1979



Digiruler
SL series

History

- 1965 Introduced magnetic scale technology
- 1969 Established Sony Magnescale Co., Ltd. to develop, design, manufacture Magnescale magnetic scale products
- 1971 Released Magnescale GP series
- 1978 Released Counter LM series
- 1981 Established Isehara plant
- 1988 Released Laserscale BS10 series
- 1996 Changed company name to Sony Precision Technology Inc.
- 2002 Released Laserscale BL55 series
Introduced high-precision magnetic recording technology
- 2003 Released high-precision Magnescale SR33 series
- 2004 Changed company name to Sony Manufacturing Systems Corporation
- 2005 Released Magnescale SJ300 series, high-precision digital gauge DK800 series, and network counter system MG series
- 2007 Released high-precision absolute Magnescale SR70 series
- 2008 Released Magnescale GB-ER series, counter LH70 series
Released high rigidity and precision absolute Magnescale SR80, RU70 series
- 2010 Established Magnescale Co., Ltd.
- 2012 Released the high-sliding performance and a highly rigid digital gauge DK800S series
- 2013 Released second-generation ABS linear/rotary Magnescales developed for various CNC machine tool manufacturers
Released the easy-to-install Laserscale BF series

1960

19

1970

1977



Counter
LY101

1972

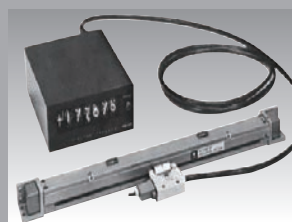

Flux response-type linear scale
GP

Released the
Magnescale
GP series

1978



Flux response-type gauge
DG800

1988



Laserscale BS10/15

Released the Laserscale BS10 series

2007



ABS linear/rotary Magnescales SR70/RU70 series

Released the highly rigid and high-precision absolute Magnescales SR70/RU70 series

1984

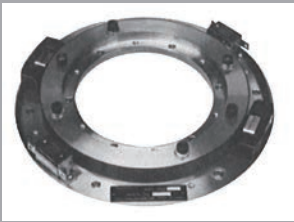

Flux response-type rotary scale RS1

2002

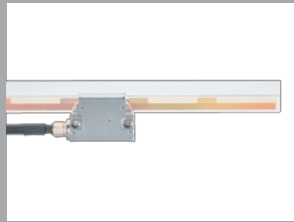

Laserscale BS78

2012

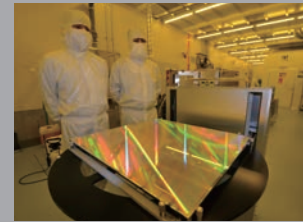

Large 2D Laserscale

80 2000 ToBe

History of Magnescale

1990 2010

1995



Magnetic resistance change type gauge DT series

2012

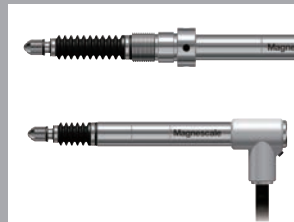

High-sliding performance digital gauge DK800S series

2012



ABS linear scale SR67A series

1998

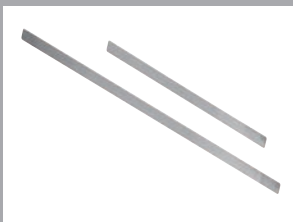

Digiruler SL700

Non-contact type digital scales capable of high resolution, analog output, and zero-point detection

2012



Laserscale BF series

Easy-to-install Laserscale BF series with excellent maintainability

2012

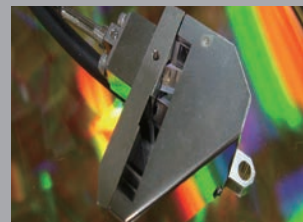

Laserscale Z sensor

Picometer level resolution Enables high-precision 2D and 3D measurements with 1D and 2D

Magnescale Co., Ltd.

Established	March 31, 2010
Capital	1 billion yen
Number of employees	266 (As of April 1, 2013)
Representative	Chairman, Representative Director: Masahiko Mori President and CEO, Representative Director: Toru Fujimori
Main business	Manufacturing and sales of precision measuring instruments
URL	www.magnescale.com

Offices

Headquarters	45 Suzukawa, Isehara-shi, Kanagawa 259-1146, JAPAN TEL:+81(0)463-92-1011 FAX:+81(0)463-92-1012
Iga Plant	Development building 2F, 201 Midai, Iga city, Mie 519-1414, JAPAN TEL:+81(0)595-45-2663 FAX:+81(0)595-45-2683
Tokyo Office	Shinagawa Intercity Tower A-18F, 2-15-1, Konan, Minato-ku, Tokyo 108-6018, JAPAN TEL:+81(0)3-5460-3574 FAX:+81(0)3-5460-9614
Nagoya Office	2-35-16, Meieki, Nakamura-ku, Nagoya Aichi, 450-0002, JAPAN TEL:+81(0)52-587-1823 FAX:+81(0)52-587-1848
Osaka Office	2-14-6, Nishi-Nakajima, Yodogawa-ku, Osaka 532-0011, JAPAN TEL:+81(0)6-6305-3101 FAX:+81(0)6-6304-6586
International Sales Department	45 Suzukawa, Isehara-shi, Kanagawa 259-1146, JAPAN TEL:+81(0)463-92-7971 FAX:+81(0)463-92-7978
Magnescale Americas Inc.	5740 Warland Drive, Cypress, CA 90630, USA TEL:+1(562)594-5060 FAX:+1(562)594-5061
Magnescale Europe GmbH	Antoniusstrasse 14, 73249 Wermau, Germany TEL:+49(0)7153 934 291 FAX:+49(0)7153 934 299

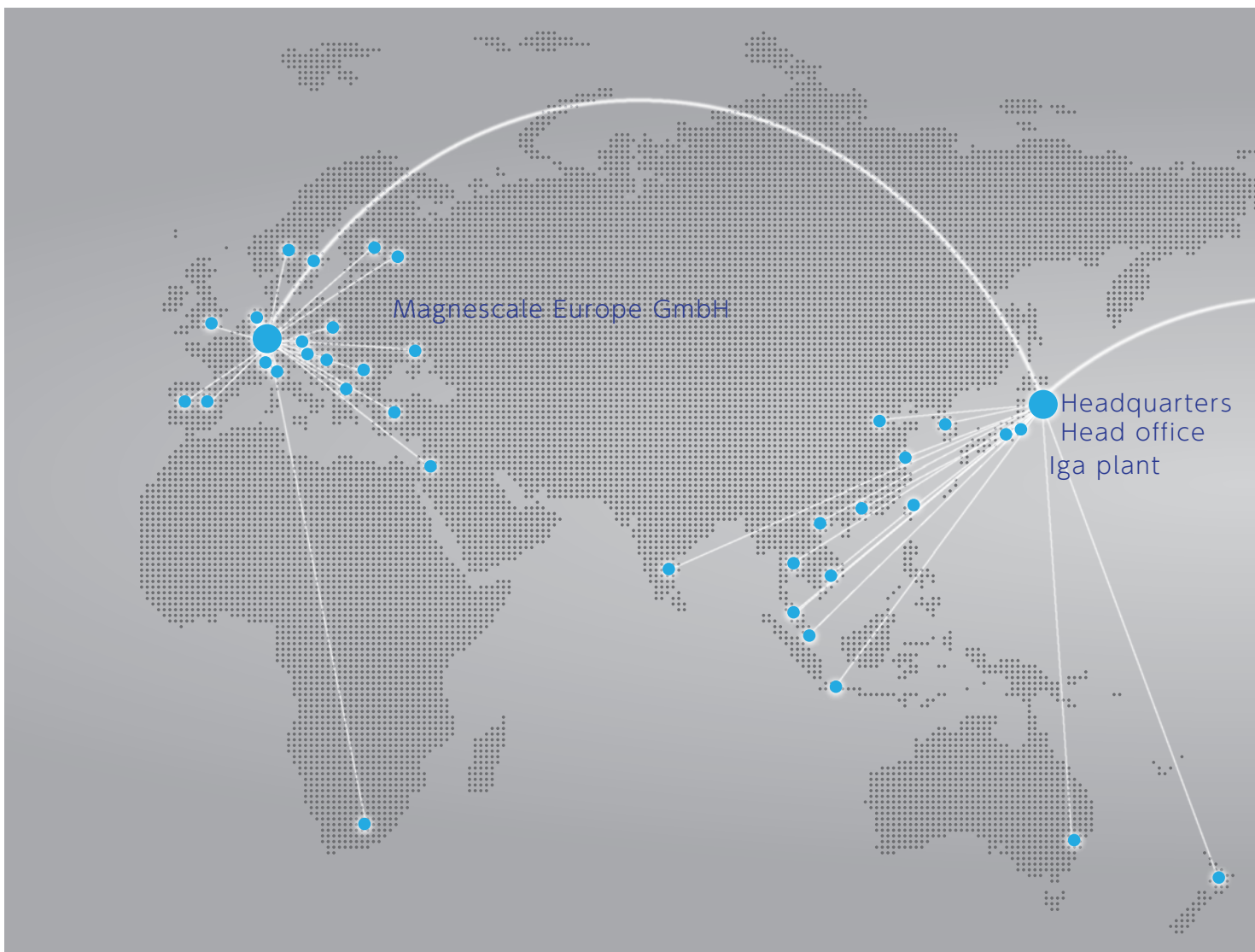



Headquarters



Iga plant

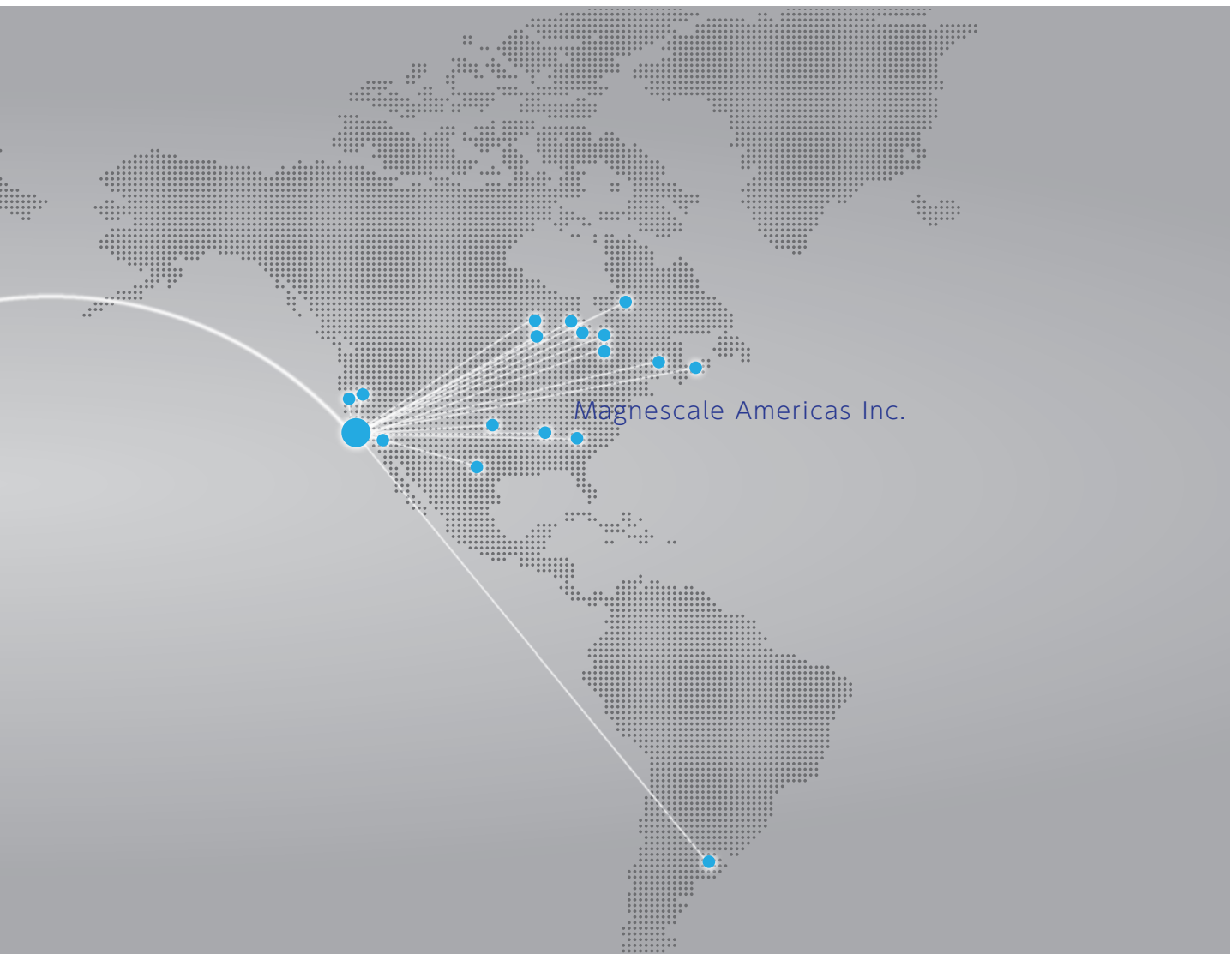

Magnescale Americas Inc.

www.magnescale.com

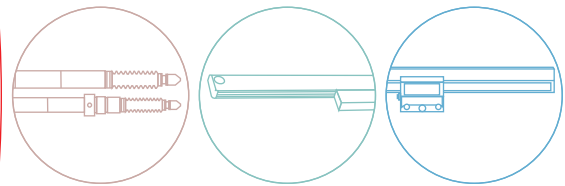

Magnescale Co., Ltd.

Headquarters	Shinagawa Intercity Tower A-18F, 2-15-1, Konan, Minato-ku, Tokyo 108-6018, JAPAN 45 Suzukawa, Isehara-shi, Kanagawa 259-1146, JAPAN TEL:+81(0)463-92-1011 FAX:+81(0)463-92-1012
Iga Plant	Development building 2F, 201 Midai, Iga city, Mie 519-1414, JAPAN TEL:+81(0)595-45-2663 FAX:+81(0)595-45-2683
Tokyo Office	Shinagawa Intercity Tower A-18F, 2-15-1, Konan, Minato-ku, Tokyo 108-6018, JAPAN TEL:+81(0)3-5460-3574 FAX:+81(0)3-5460-9614
Nagoya Office	2-35-16, Meieki, Nakamura-ku, Nagoya Aichi, 450-0002, JAPAN TEL:+81(0)52-587-1823 FAX:+81(0)52-587-1848
Osaka Office	2-14-6, Nishi-Nakajima, Yodogawa-ku, Osaka 532-0011, JAPAN TEL:+81(0)6-6305-3101 FAX:+81(0)6-6304-6586
International Sales Department	45 Suzukawa, Isehara-shi, Kanagawa 259-1146, JAPAN TEL:+81(0)463-92-7971 FAX:+81(0)463-92-7978
Magnescale Americas Inc.	5740 Warland Drive, Cypress, CA 90630, USA TEL:+1(562)594-5060 FAX:+1(562)594-5061
Magnescale Europe GmbH	Antoniusstrasse 14, 73249 Wermau, Germany TEL:+49(0)7153 934 291 FAX:+49(0)7153 934 299

<http://www.magnescale.com> Note: Click on the URL to the left to obtain technical information.

Information in this catalog: Up to date as of January 2014
This catalog is printed using vegetable oil ink.

