

PRODUCT OVERVIEW



PRODUCT OVERVIEW

INDUCTIVE SENSORS (LVDT) | EDDY CURRENT SENSORS | DIGITAL GAUGES,
DIGITAL RULERS, DIGITAL MAGNETIC SCALES | LASER SENSORS

MEASUREMENT TECHNOLOGY FOR SENSING DISTANCE AND POSITION



eddylab GmbH is a modern company, which has been passionately developed, engineered and produced sensors for the measurement of distances and positions, for 20 years. We even provide entire system solutions. The company is based in Otterfing, in the south of Munich. The development, production and sales of the sensors are carried out from here. In addition, we are able to provide our customers a worldwide network of distributors. Our experts have extensive application experience and offer competent, technical support to find the perfect solution for every measurement task.

Our focus is on eddy current sensors and inductive sensors, called LVDT. eddylab is also the official distributor of Magnescale products (formerly Sony Precision Technology), which stand for high-precision, high-resolution and robust sensors. Laser distance sensors complete the range and are used when a non-contact, optical measuring method is required.

Short term product availability

eddylab GmbH offers short term available products for a variety of industrial applications in factory and process automation, test benches as well as research and development at an attractive price-performance-ratio. In many cases our products can be configured to meet our customer's needs: A wide range of technical options ensures that the sensors can be perfectly adapted to different requirements (for example, an increased protection class, an extended temperature range or even the combination of different options).

Customized solutions for special tasks

On our high-end calibration machines, we can do customer specific calibration regarding measurement range, target materials and so on.

In addition, our strength is the development of custom-made sensors. In close cooperation with our customers we develop ultra precise sensors true to the motto „sensors - built to perform!“ In this context, we realize both individual pieces as well as medium and large series for OEM integration.

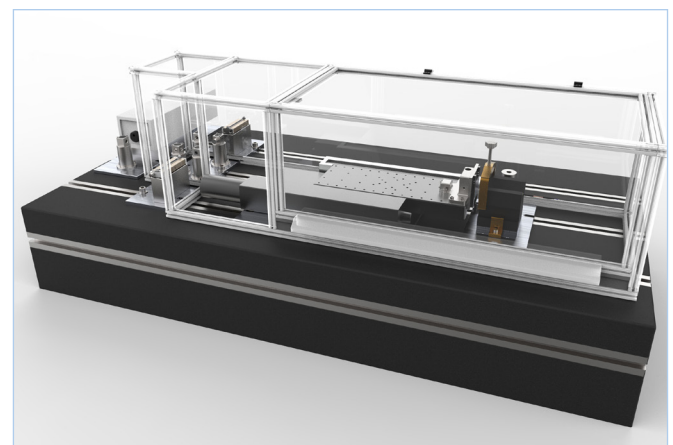

Development of specific sensors

Are you looking for precisely measuring sensors that provide exact measuring results for your specific application? Then we are the right company for you. As a specialist in distance and position measurement technology, we produce high quality sensors for your applications on a daily basis.

Production of high-precision sensors

Constant innovation and development are essential aspects of our business today and, thus, an integral part of our daily work. With the know-how accumulated by our team over many years, we are able to improve our products with passion every day, enabling us to take new paths in the world of position measurement technology. If you require special solutions for your application, just contact us. We will put all our know-how and ability into designing the right system for you.

Non-bureaucratically we realise custom-made sensors with modifications according to:

- Temperature specification
- Design and geometry
- Protection class (IP68, IP69K)
- Pressure specification
- Vibration resistance
- Vacuum application
- Redundant systems
- Output signal

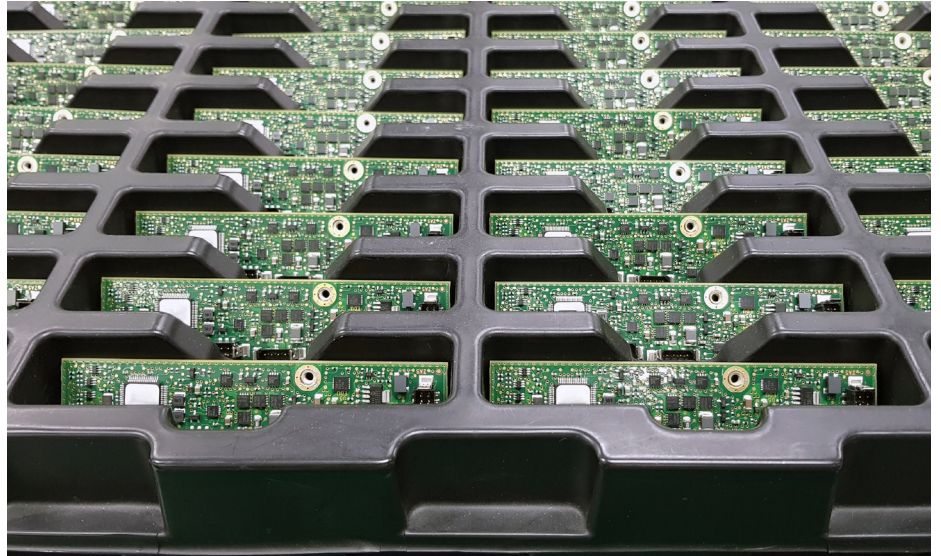



INDUCTIVE SENSORS - LVDT

The measuring system

Insensitive and reliable. LVDT displacement transducers from eddylab GmbH are inductive full bridges that work virtually wear-free. The differential measuring principle of our LVDTs ensures minimum temperature effects on the results of the measurements. Therefore the system is insusceptible to electromagnetic external interference. The LVDTs are characterized by their exceptional ruggedness and reliability under harsh conditions, despite their high resolution and repeat accuracy. Even demanding operating conditions as high temperature areas (up to 200° C), high pressures (up to 400 bar) or heavy vibration loads pose no problem for the LVDT sensors.

High protection classes and high quality housing like stainless steel and titanium ensure an application under water. The LVDTs are also built to withstand contact with aggressive chemical products, which are used for cleaning and disinfection in pharmaceutical, medical and food industry applications. The pressurized hydraulic versions are designed for installation in hydraulic and pneumatic cylinders or servo valves. eddylab GmbH offers LVDT sensors with a measuring range from ± 1 mm (2 mm) up to ± 300 mm (600 mm). The eddylab product range comprises six different series. That ensures to have a suitable measuring system for every application.

Key-Features

- High precision and linearity
- Repeatability up to 0,1 μ m
- Excellent ratio between measuring range and housing length
- Temperature up to 200 °C
- Very good temperature coefficient
- Numerous signal outputs

Customer benefits

- Various configuration options for optimal adaption
- Long life cycle and high reliability
- Plug and play (complete measurement chain)
- Calibration certificate always included

Applications

- Flight simulator positioning
- Cylinder stroke control for mold oscillation
- Leak tightness control of cups during yoghurt filling
- Steam Pipe Monitoring

OVERVIEW SERIES – LVDT

■ SM SERIES

Our standard series for almost all applications in industry and laboratory

- Various possibilities of configuration
- Push-rod guided and unguided, spring loaded
- Linearity up to 0,10 %
- Measuring ranges 2...200 mm



■ SLT SERIES

Ultra robust LVDT series with spring loaded and air actuated versions. Measurement ranges up to 300 mm

- Measuring ranges 10...300 mm
- Type: spring loaded mechanism, pneumatic version PR1: pressurized air extends push rod, pneumatic version PR2: pressurized air retracts push rod
- Linearity up to 0,10 %



■ SL SERIES

Ultra-robust construction, complete stainless steel housing of 20 mm diameter and 8 mm diameter push-rod

- Rod end bearings, push-rod guided and unguided
- Linearity up to 0,10 %
- Measuring ranges 10...600 mm



■ SLX SERIES

Ultra-robust construction, adapted to environmental condition in pharmaceutical, medical and food industry

- Rod end bearings, push-rod guided/ unguided
- Linearity up to 0,10 %
- Protection class IP68/IP69K
- Measuring ranges 10...300 mm

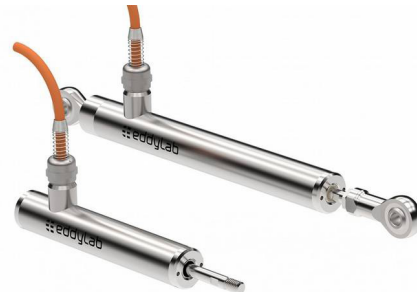

■ HYD SERIES

Pressure resistant up to 400 bar for integration in hydraulic cylinders and servo valves

- Different flanges
- Linearity up to 0,10 %
- Measuring ranges 2...180 mm



■ F18 SERIES

Designed for applications in hydraulic and pneumatic cylinders. Pressure resistant up to 150 bar

- Push-rod, spring loaded
- Linearity up to 0,10 %
- Measuring ranges 2...200 mm



F14 SERIES

Designed for integration into hydraulic and pneumatic cylinders and for servo valves. Pressure resistant up to 150 bar

- Compact design
- Push-rod, spring loaded
- Linearity up to 0,10 %
- Measuring ranges 2...10 mm



DEEneo - DIGITAL SIGNAL CONVERTER LVDT

Digital signal converter for DIN rail mounting

- Configurable output signal
- Digital signal processing with TEACH-function
- Resolution 16 bit
- Cable break detection, alarm output, switching output



DEEneo-ISC - INLINE SIGNAL CONDITIONER LVDT

Cable electronics integrated in sensor cable

- Configurable output signal
- Digital signal processing with TEACH-function
- Resolution 16 bit
- Cable break detection



DEEneo-ISC-IP68 - INLINE SIGNAL CONDITIONER

Cable electronics integrated in sensor cable

- Anodized aluminium housing
- Protection class IP68, sealed up to 10 bar
- Configurable output signal
- Digital signal processing with TEACH-function
- Resolution 16 bit
- Cable break detection



TX-LVDT

Digital controller for highly accurate measurement results without linearity errors

- Linearity up to 0,01 %
- Resolution 16 bit
- Analog and digital output (CAN, USB)
- Software included



eddySETUP | eddyMOTION LVDT STANDARD

eddySETUP software tool for DEEneo, DEEneo-ISC, DEEneo-ISC-IP68

- Configuration of digital signal conditioners
- Sensor supply: Frequency, amplitude
- Output signal selection
- Teach function
- Available as download

eddyMOTION LVDT software tool for TX LVDT

- Analysis and documentation of mechanical movements
- Scope of functions: oscilloscope, data logger, configuration
- Available as download

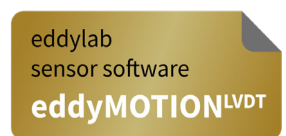
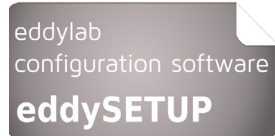

eddy current
software tool

eddyMOTION

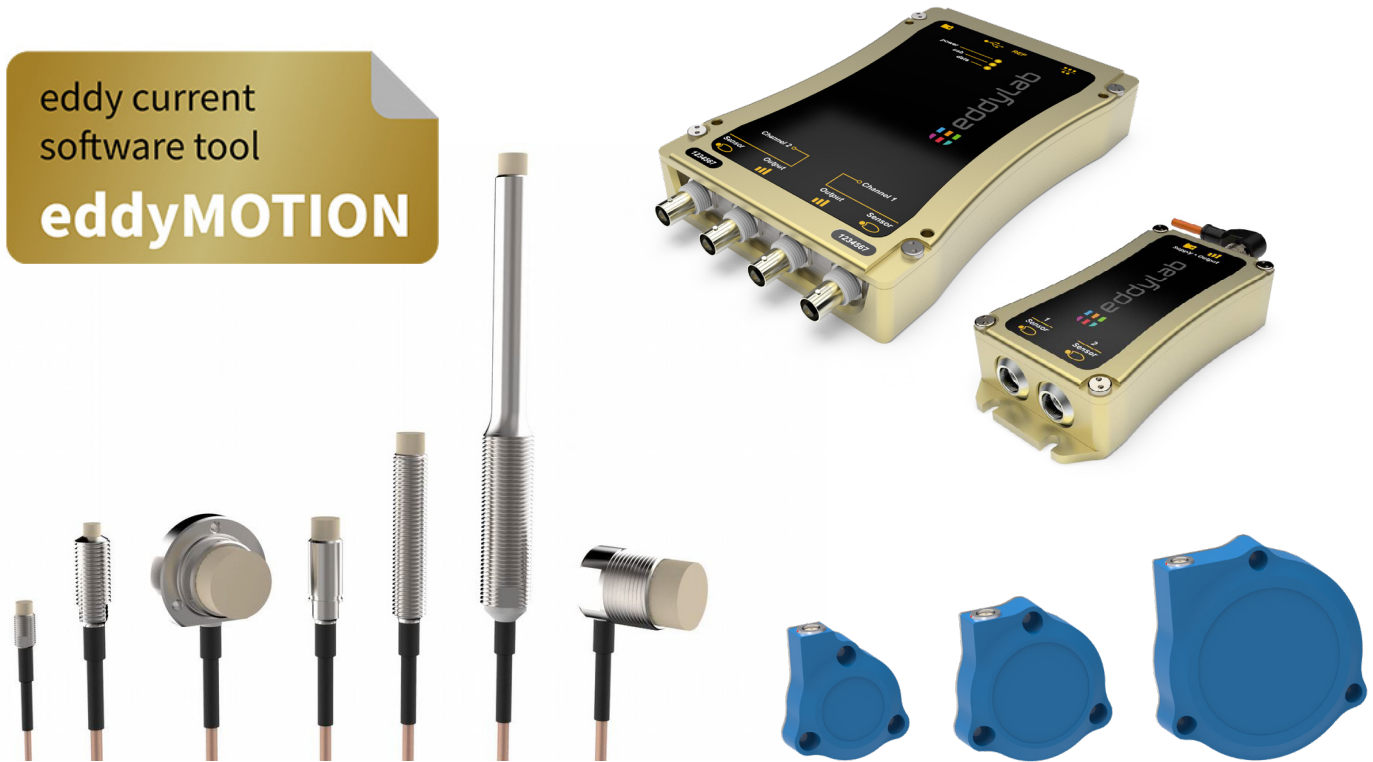

EDDY CURRENT SENSORS

The measuring system

Eddy current sensors detect the distance or the change to metal objects without contact, dynamically and extremely accurately. The TX electronics which are specially adapted to the respective sensor calculate an analog output signal proportional to the distance. In addition, there is a USB and CAN interface for reading the data. The **eddyMOTION software** for configuration and analysis of the measurement data is the perfect complement to the TX series. For more information see www.eddycurrentprobe.com

Key-Features

- High precision measurement, resolution max. 30 nm
- Linearity up to 0,15 %
- Various sensor-geometries available
- Linearisation function
- Sampling rates up to 124 kSa/s
- Robust, highly dynamic sensors
- Operating temperature -60...+180 °C
- Enormous temperature and pressure stability
- Different analog signal outputs, digital outputs USB/CAN
- Inclusive software-tool eddyMOTION, free-download: www.eddylab.com/service/Downloads
- Traceable linearisation und calibration

Customer benefits

- Contactless measurement
- Increase of process reliability
- Calibration certificate always included
- Plug and play for complete measurement chain (sensor-cable-electronic)
- Maintenance-free operation

Applications

- Glue gap control in corrugated paper production
- Shaft displacement at the gearbox test bench
- Speed measurement in turbocharger
- Spindle growth compensation

OVERVIEW SERIES – EDDY CURRENT SENSORS

■ TX SERIES

High-end-product for almost all applications in industry und laboratory

- Measuring ranges 0,5...10 mm
- Linearity up to 0,15 %
- Various sensor head models available
- 1- and 2- channel TX electronic modules available
- Analog and digital outputs (USB/CAN)

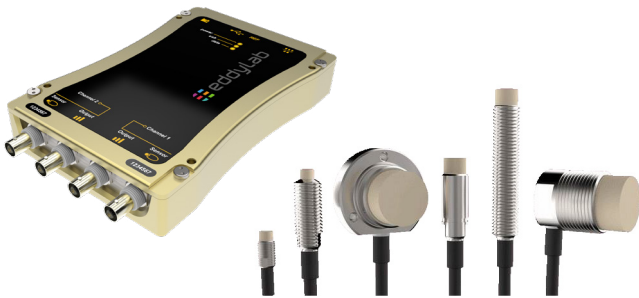

■ AX SERIES

High precision analog eddy current sensors

- Measuring ranges 0,5...10 mm
- Linearity up to 2 %
- Various sensor head models available
- 1- and 2- channel AX electronic modules available
- Analog outputs



■ CM SERIES

Ultra-compact sensors with ceramic housing, pressure- and temperature-resistant

- Measuring ranges 0,3...2 mm
- Pressure resistance up to 200 bar
- Temperature range up to 200 °C
- Compact dimensions



■ T14/T20/T40 SERIES

New eddy current sensors for long measuring ranges up to 45 mm

- Measuring range 0...45 mm
- Temperature ranges up to 150 °C
- Linearity up to 0,15%
- Protection class IP68

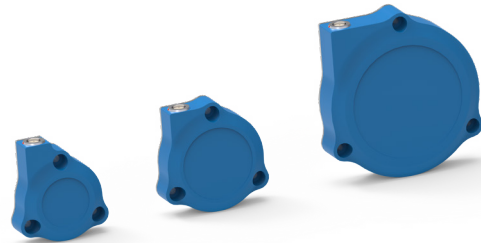

■ AX-TURBO

Eddy current measuring system for turbo speed measurement and gap control on turbo vanes and shafts

- Distance to vane 0...2 mm
- TTL output for speed measurement up to 900.000 rpm
- Analog monitor output for gap control

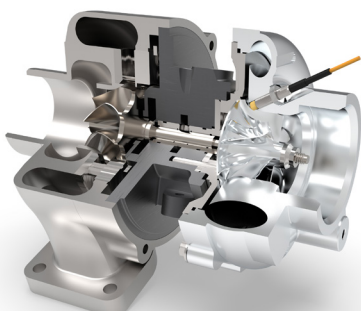

■ IC SERIES

Low-cost series with integrated electronics

- Measuring ranges 2/3/8/18 mm
- Linearity $\pm 60 \mu\text{m}$
- Analog outputs

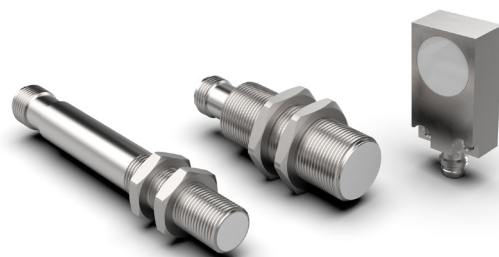

OVERVIEW SERIES – EDDY CURRENT SENSORS

■ CT SENSORS

Pressure-resistant sensors for extremely harsh conditions

- Measuring ranges 0...10 mm
- Linearity 0,15 %
- Pressure resistant up to 220 bar
- Protection class IP68/69K
- Protection hose



EDDY CURRENT SOFTWARE TOOL EDDYMOTION

Windows analysis software tool via USB

eddyMOTION is a powerful windows software used in conjunction with the TX-Driver. The targeted area of application is the visualisation and documentation of mechanical motion and the on-site linearization of eddy current sensors.

Key-Features

- Configuration of TX-electronics (choice of calibration curve, filter)
- [Free Download](#)
- Visualization and documentation of mechanical movement
- Includes functional areas oscilloscope, FFT, waterfall, waterfall RPM, data logger
- On-site linearization of eddy current sensors possible



eddyMOTION as an analysis tool

eddyMOTION is made up as an universal analysis tool for the USB based data stream from the TX-Driver. The requirements in signal analysis can be of various nature - therefore eddyMOTION is structured in several modules. The different modules can be used to monitor fast and slow motion. The measured data can be displayed in the time- and in the frequency domain. The underlying sampling rates are 22.5 kSa/s in the two channel version and 38 kSa/s in the single channel version.

eddyMOTION offers an Oscilloscope function and further features like FFT analyser, Waterfall and Data logger. eddyMOTION also enables the on-site linearisation of eddy current sensors with an active feedback system.



DIGITAL GAUGES | MAGNESCALE

The measuring system

Magnescale® (formerly SONY Precision Technology) gauges are high-precision sensors which, through their unique magnetic measuring principle, permanently achieve a resolving power of up to 0.1 microns and an accuracy of up to 0,5 μm , even under difficult conditions. The newly developed shaft keyway bearing of the DK800S series guarantees a lifespan of more than 130 million strokes. With their RS422 compatible output signal, digital gauges are the ideal sensors for automated manufacturing.

Key-Features

- High-precision digital gauges
- Measuring ranges 5...205 mm
- Resolution up to 0,1 μm
- Linearity up to 0,5 μm
- Pneumatic versions available
- Reference point (partly)
- Incremental TTL signal
- Interface module with Ethernet or RS232C interface

Customer benefits

- Resistant to water and oil
- Free software for digital gauges with USB interface (DS series)
- Various displays (1 or 2 channel) available
- Versions with interpolator unit MT14 or MT30 as a complete set

Applications

- Stroke measurement in material testing machines
- Multipoint inspection appliances
- Quality assurance and process control
- Production measurement technology

OVERVIEW SERIES – DIGITAL GAUGES

DK800S SERIES

High precision digital gauges with measuring ranges up to 30 mm

- Resistant to water and oil
- Resolution up to 0,1 μm
- Linearity up to $\pm 0.5 \mu\text{m}$
- TTL Linedriver (RS422)



DS SERIES WITH USB INTERFACE

The digital gauge can be interfaced to a PC easily

- Measuring ranges 5...100 mm
- USB (2.0FS) interface - free data analysis software available
- Pneumatic versions available
- Resolution up to 0,1 μm
- Linearity up to 1 μm



DT SERIES

Compact and slim gauges with measuring ranges up to 60 mm

- Resolution 1 μm
- Linearity max. $\pm 3 \mu\text{m}$
- TTL Linedriver to RS422, with MT-Interpolator



DK SERIES

High accuracy, rugged gauges. Suitable for installation on machine

- Measuring ranges 10...205 mm
- Protection class IP64
- TTL Linedriver (RS422)



MG-40/41 MULTI POINT MEASURING DEVICE

Measuring device - up to 100 digital gauges

- Modular structure
- Ethernet output
- Baud rate 10 mbps data transfer



MG80+LT80/ETHERNET/ETHERNET IP/PROFINET

Measuring device - up to 32 digital gauges of DK and DT series

- Modular structure
- Data storing and Parameter writing in SD card/USB memory / Data is transferred to PC via Ethernet, Ethernet IP or Profinet
- MG80 + LT80: 7-inch touch screen LCD display (1024x600)





DIGITAL MAGNETIC SCALES AND DIGITAL RULERS | MAGNESCALE

Digital Magnetic Scales

Magnescape® (formerly SONY Precision Technology) scales consist of a rigid profile with integrated magnetic tape on which a movable reading head is mounted. When shifting from registered magnetic pulses, this high precision sensor generates an incremental output signal which corresponds to the RS422 standard. These digital length measuring devices are ideal for mounting on multi-axis systems, such as lathes and milling machines, or robot systems.

Digital Rulers

Digital magnetic tape measurement systems by Magnescape® (formerly SONY Precision Technology) consist of a linear magnetic material and a reading head, which is fed without contact over the magnetic tape. This measuring principle is permanently wear-free, very robust and enables the highest resolutions up to 0.2 microns.

Key-Features

- Measuring ranges 50...50000 mm
- Resolution up to 0,005 μm
- Linearity up to 0,25 μm
- Output incremental TTL/HTL
- Non-contact measuring-system
- Integrated reference point (partly)
- Resistant to water, oil and vibration
- Various multifunction counter

Customer benefits

- High resistance to contamination
- Mounting flexibility
- Permanently wear-free
- Resolution up to 0,2 μm

Applications

- Lathes, grinding and milling machines
- Multi-axis systems
- 3D printer
- Length and position measurement
- Measuring devices and special mechanical engineering

OVERVIEW – DIGITAL MAGNETIC SCALES AND RULERS – MAGNESCALE

■ SJ-700A SERIES

Digital Magnetic Scale

- Measuring ranges 150...1600 mm
- Resolution 5 μm
- Linearity max. $\pm 10 \mu\text{m}$
- Protection class IP54
- TTL Linedriver A/A*, B/B*, Z



■ GB-ER SERIES

High precision digital Magnetic Scale

- Measuring ranges 50...2200 mm
- Resolution 0,5 μm
- Linearity up to $\pm 5 \mu\text{m}$
- Protection class IP54
- TTL Linedriver A/A*, B/B*, Z



■ SR SERIES

Digital Magnetic Scale

- Measuring range 70..3640 mm
- Resolution 0,01 μm
- Protection class IP54/IP65
- RS485, DRIVE-CLIQ
- High vibration resistance



■ PL20C

Digital Magnetic Ruler

- Magnetic Ruler SL110, SL130
- Measuring ranges 200...30000 mm
- Resolution up to 10 μm
- Protection class IP65
- TTL Linedriver (RS422), A/A*, B/B*



■ PL25 WITH MJ 100/110 INTERPOLATOR

Digital Magnetic Ruler

- Magnetic Ruler SL110, SL130
- Measuring ranges 200...30000 mm
- Resolution 5/10/25/50/125 μm , adjustable
- Protection class Lesekopf IP65
- TTL Linedriver (RS422)



■ PL60 WITH MJ 100/110 INTERPOLATOR

Digital Magnetic Ruler

- Magnetic Ruler SL331
- Measuring ranges 200...8000 mm
- Resolution 5/10 μm , adjustable
- Protection class IP65



■ PL81, PL82

Digital Magnetic Ruler

- Magnetic Ruler SL110, SL130
- Measuring range 200...30000 mm
- Resolution 10/20/25/50/100 μm , adjustable
- Protection class IP67
- TTL Linedriver (RS422), A/A*, B/B*



■ PL101 WITH MJ100/110 INTERPOLATOR

Digital Magnetic Ruler

- Digital Magnetic Ruler SL700 series
- Measuring range 50 mm...100 m
- Resolution max. 0,2 μm
- Protection class IP50 - IP67
- 1 Vss, Sin, Cos, TTL Linedriver (RS422), w/A/A*, B/B*, Z





LASER SENSORS

The measuring system

The digital laser sensors of the AXIS and HG-C series measure the distance or the position of an object in a highly reliable, non-contact and wear-free manner according to the triangulation principle. The sensor emits a laser beam which is reflected by the target. After the reflected light has been focused by a lens, it strikes a highly sensitive CMOS sensor at a predefined angle. A change of the distance to the measuring object causes a change of angle and the light spot on the CMOS sensor shifts. This geometric principle is used to calculate the distance of the measuring object. Thanks to the integrated electronics, the sensor automatically adapts to different materials and their optical reflection. The AXIS sensors deliver stable measurements and reliable results even on demanding and changing surfaces. Laser sensors are available in different sizes and ranges depending on customers requirements.

Key-Features

- Measuring ranges 10 mm - 13 m
- Resolution up to 0,7 μm
- Various ranges, housing sizes and beam shapes available
- High immunity to ambient light
- Vibration-resistant
- Low temperature drift in the event of ambient temperature fluctuations
- Laser point or line beam for demanding surfaces

Customer benefits

- Fast, economical start-up thanks to Plug & Play
- Fast and simple adjustment of the measuring range using the teach-in button
- Excellent cost-benefit ratio
- Factory-calibrated sensors with measuring values displayed in millimeters

Applications

- Measuring distances on printing plates
- Yarn length measurement with laser line beam
- Measurement of tire profiles on a brake test stand
- Position verification of assembly parts

OVERVIEW – LASER SENSORS

■ AXIS-MI-10/104

Miniature sensors, small and compact housing, high precision

- Measurement ranges 10/104 mm
- Resolution 1...35 μm
- Linearity $\pm 0,08\%$ MR... $\pm 0,16\%$ MR
- Protection class IP67
- Output 0...10 V / 4...20 mA / RS485



■ AXIS-MI-50/300/500

Miniature sensors, small and compact housing, high precision

- Measurement ranges 50/300/500 mm
- Resolution 1 - 160 μm
- Linearity $\pm 0,08\%$ MR... $\pm 23\%$ MR
- Protection class IP67
- Output 0...10 V / 4...20 mA / RS485 / RS232



■ AXIS-P

Performance sensors, powerful sensors for factory automation

- Measurement ranges 40...600 mm
- Resolution 4 - 2500 μm
- Linearity $\pm 0,15\%$ MR... $\pm 0,40\%$ MR
- Protection class IP67
- Output 0...10 V / 4...20 mA



■ AXIS-P800

Performance sensors, powerful sensors for factory automation

- Measurement ranges 40...800 mm
- Resolution 20 - 400 μm
- Linearity $\pm 0,21\%$ MR
- Protection class IP67
- Output 0...10 V / 4...20 mA



■ AXIS-HP, SHORT- UND MID-RANGE

High-Performance sensors – sensors with measuring accuracy in the sub-micro-meter range

- Measurement ranges 40...1350 mm
- Resolution 0,7 - 125 μm
- Linearity $\pm 0,06\%$ MR... $\pm 0,32\%$ MR
- Protection class IP67
- Output 0...10 V / 4...20 mA / RS485



■ AXIS-LR

Long-Range sensors for distances up to 13 meters

- Measurement ranges 3800...12800 mm
- Resolution 1,3 - 5 mm
- Linearity $\pm 0,11\%$ MR... $\pm 0,49\%$ MR
- Protection class IP67
- Output 0...10 V / 4...20 mA



■ HG-C

Miniature sensors, small and compact housing

- Measurement ranges 10...400 mm
- Linearity $\pm 0,1\%$
- Protection class IP67
- Output 0...10 V / 4...20 mA
- Attractive price-performance ratio



